



---

Installation, Operation & Maintenance Manual

# AromaSteam

Fragrance Metering Pump System for  
Residential and Day Spa Steam Rooms

Part Number MS AROMA (120V)

---

**IMPORTANT:** Leave this material with the home owner.

---

mr.steam® | Feel Good Inc.®

**⚠ WARNING** This installation, operation and maintenance manual is for general reference. The installation, operation and maintenance manual supplied with the product must be used for installation, operation and maintenance purposes. Failure to use the installation, operation and maintenance manual supplied may result in a property damage or personal injury.

# INSTALLER SECTION

## BEFORE INSTALLING

Carefully inspect the AromaSteam pump and packaging for shipping damage. In the event of shipping damage, please contact the carrier for claim information. Our customer service department can assist you with product replacement.

Read these instructions before installation or service. Although the AromaSteam pump has been fully qualified for shipment by MrSteam, the following must be reviewed for proper, safe and enjoyable steam bathing:

1. Verify that the model and accessories specifications are correct for the application.
2. The physical size of the unit, clearance for plumbing servicing, its distance from the steam room and fragrance location must all be considered before final installation.
3. Consider any controls and accessories before initiating installation. Read the Installation and Operation Manual of all controls and accessories available at [www.mrsteam.com](http://www.mrsteam.com) technical downloads.

### IMPORTANT NOTES:

This document contains important safety, operation and maintenance information. After installation leave this document with the homeowner. Do not discard this document.

The following general information should be used in conjunction with consultations with an architect, designer and contractor in determining factors necessary in providing a suitable and safe steam room. MrSteam AromaSteam pumps are intended to be operated with MrSteam iSteam®, AirTempo®, iTempoPlus® and iTempo® controls only, and are to be installed strictly in accordance with the specific instructions contained in this manual and as supplied in the manuals provided with the controls or accessories.

## TABLE OF CONTENTS

### Installer’s Section:

- Box Contents..... 3
- Important Safety Information ..... 4
- System Overview..... 5
- General System Dimensions ..... 6
- General Installation ..... 7-11
- Operation ..... 12
- Troubleshooting..... 13
- Replacement Parts ..... 14
- Installing the Caddy ..... 15-16

### Homeowner’s Section

- Fragrances ..... 17
- Important Safety Information ..... 18
- Locating the Caddy..... 19
- Pump Operation..... 19-20
- Warranty ..... 20

## WARNING

This room is equipped with a fragrance dispensing system.

Leave the room immediately if you have any adverse or allergic reactions, including difficulty breathing or eye, nasal, throat, or skin irritation and seek medical attention.

mr.steam® 43-20 34th Street, Long Island City NY 11101 1-800-76 STEAM [www.mrsteam.com](http://www.mrsteam.com) PUR100405 2/06

**IMPORTANT NOTE:** This “peel and stick” warning label shall be posted in a conspicuous location next to the steam room door.

# INSTALLER SECTION

## Box Contents

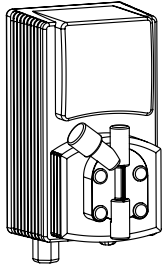

**Pump**

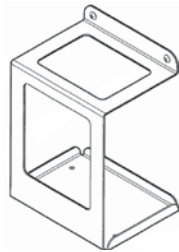

**Caddy**



**Pressure Tube Assembly**



**Suction Tube Assembly**

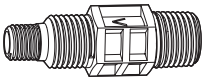

**Check Valve**

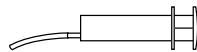

**Injector with  
Injector Tubing**



**Installation & Operation  
Manual** with peel and stick  
Warning label

Additional Items included but not shown:

- 2x Mounting Screws and Anchors for Caddy and Pump
- Fuse

*All Drawings for Illustrative Purposes Only*

**IMPORTANT NOTE:** As you follow these instructions, you will notice warning and caution symbols. This blocked information is important for the safe and efficient installation and use of the pump, fragrance and caddy. These are types of potential hazards that may occur during installation and operation:

**! WARNING** states a hazard may cause serious injury or death if precautions are not followed.

**! CAUTION** signals a situation where minor injury or product damage may occur if you do not follow instructions.

**IMPORTANT NOTE:** This highlights information that is especially relevant to a problem-free installation.

All information in these instructions is based on the latest product information available at the time of publication. Sussman-Automatic Corporation reserves the right to make changes at any time without notice.

# INSTALLER SECTION

## WARNING

### FLAMMABLE LIQUID AND VAPOR

- Keep the pump and fragrance away from heat, sparks, electrical outlets, open flames such as candles and hot surfaces.
- No smoking.
- Keep Out of the Reach of Children.
- Use only non-sparking tools. Take precautionary measures against static discharge.
- Contains denatured ethyl alcohol
- In case of fire: Use CO2, dry chemical, alcohol foam, and water spray for extinction.
- Always store the MrSteam Aroma fragrances in a secure location. Keep container tightly closed and store in a cool, dry and well-ventilated place.
- Always use this Caddy.

## WARNING

- Avoid fragrance contact with eyes. May cause mild eye irritation. Ingestion may cause irritation, nausea, vomiting.
- Fragrance vapors may cause drowsiness, allergic reactions, difficulty breathing or skin irritation. If condition persists get medical attention.
- The Fragrance Safety Data Sheet provides comprehensive information about MrSteam Aroma fragrances. Contact 1-800-767-8326 or go online at [www.mrsteam.com](http://www.mrsteam.com) for a copy of the Safety Data Sheet.
- MrSteam fragrances (MS OIL 1- 5) are only for use with the MrSteam AromaSteam dispensing pump (part number MS AROMA and MS AROMAC). Never use MrSteam fragrances in any other pump, spray or dispensing device. The use of MrSteam fragrances in any other device may cause personal injury.
- The use of any fragrances other than MrSteam fragrances with a MrSteam AromaSteam dispensing pump may introduce excessive concentration of fragrances into the steam room, resulting in personal injury.
- Keep out of the reach of children.
- Always install the Check Valve. Failure to install the Check Valve may result in excessive fragrance delivery into the steam room and cause dizziness and/or personal injury.
- The AromaSteam pump has been factory set to deliver a suitable amount of fragrance into a typical sized residential or Day Spa steam room. Start with the pump volume at a very low setting. Gradually increase the volume setting until a comfortable fragrance level is reached. Do not exceed the "Recommended Setting" indicated on the pump volume.
- Do Not alter or modify any MrSteam product. Doing so may result in a personal injury.
- Discontinue use of the steam generator and control if the steam generator or control are damaged or otherwise not functioning properly. Doing so may result in an inoperative or hazardous installation
- **ELECTRICAL SHOCK HAZARD.** MrSteam AromaSteam pumps are connected to 120V line voltage and contain live electrical components. All installation and service to be performed by qualified and licensed electricians and plumbers only. Installation or service by unqualified persons or failure to use MrSteam parts may result in property damage or in a hazardous condition.
- Install according to Local and National plumbing and electrical codes.

## FIRST AID

**IN CASE OF EYE CONTACT:** Rinse the eyes immediately with plenty of water, also under the eyelids, for at least 15 minutes. If eye irritation persists: Get medical attention.

**IN CASE OF SKIN CONTACT:** Remove/Take off immediately all contaminated clothing. Rinse skin with soap and water or shower. If skin irritation persists, get medical attention.

**IF SWALLOWED:** Do not induce vomiting. Rinse mouth thoroughly with water. If conscious, give large amounts of water. If symptoms persist, call a physician.

## IMPORTANT NOTES:

- MrSteam Aroma fragrances are only for use in residential and day spa installations. Do Not use MrSteam Aroma fragrances in commercial installations.
- Not for use in acrylic or fiberglass rooms. Check with the room manufacturer to determine compatibility of these fragrances with room construction materials.
- Do Not alter or modify any MrSteam product. Doing so will void the warranty.
- MrSteam Aroma fragrances must be disposed of as hazardous waste.

# INSTALLER SECTION

## AromaSteam System Overview

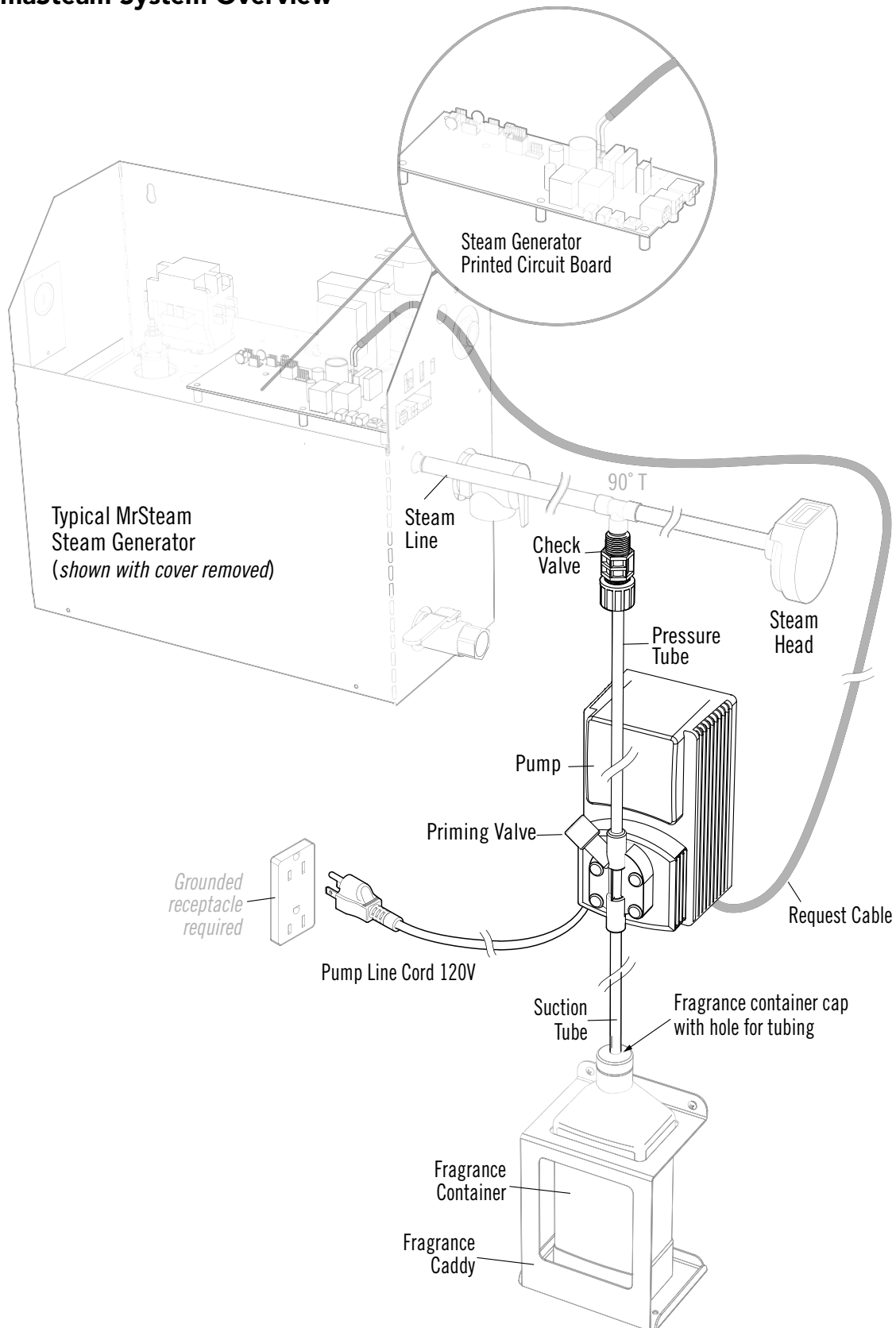

# INSTALLER SECTION

## General System Dimensions

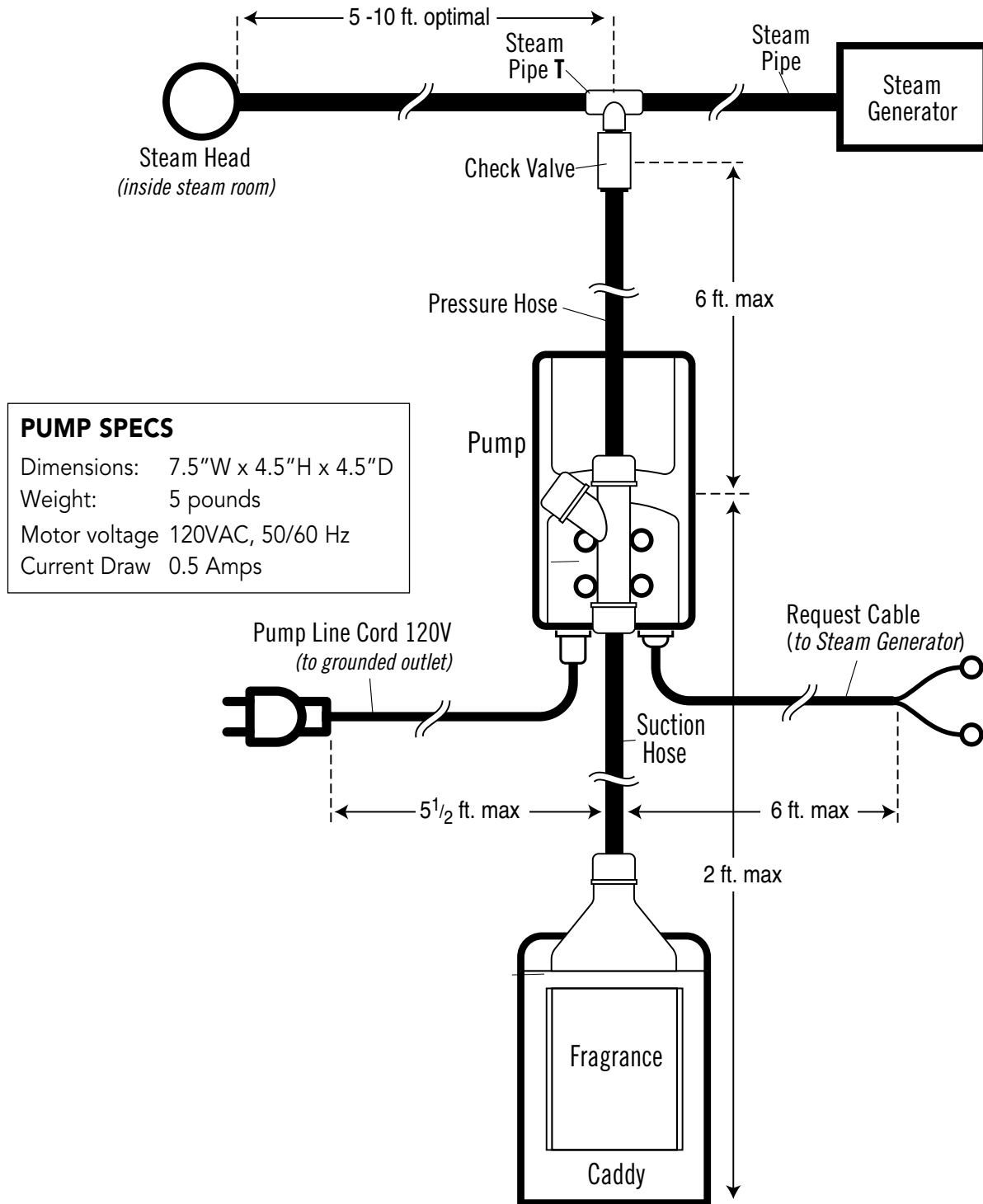

## INSTALLER SECTION

### WARNING STICKER

The warning label (*supplied on page 2*) shall be posted in a conspicuous location next to the steam room door.



Warning Sticker (*not actual size*)

### PUMP LOCATION AND INSTALLATION

1. Keep the AromaSteam System away from heat, sparks, electrical outlets, open flames such as candles and hot surfaces.
2. Locate the Fragrance and Caddy to monitor the consumption of fragrance and for easy replacement.
3. The AromaSteam System should not be installed in areas accessible to children. A locked room is strongly recommended (i.e. utility room)
4. The AromaSteam System is designed and intended for indoor use only and is to be located indoors in a dry clean location and not subject to moisture, condensation or similar high humidity environments.
5. Do not install the AromaSteam System outdoors.
6. Do not install the AromaSteam System in a location where water could freeze.
7. Do not install the AromaSteam System near corrosive materials and chemicals. Installation in areas having high concentrations of chlorine (such as pool equipment room) should be avoided.
8. Attach the AromaSteam Pump onto a secure vertical surface.
9. Use only non-sparking tools. Take precautionary measures against static discharge.

## INSTALLER SECTION

### Installing the 90 degree T and Check Valve

1. For optimal results locate a brass 90 degree **T** (not provided) in the steam supply line within 5-10 feet of the steam head. If using copper tubing for steam lines, install a female 1/2 NPT or 1/4 NPT reducing Tee in the steam line facing downward.
2. **T** must face downward as shown.

**IMPORTANT NOTE:** Follow the installation instructions for the steam pipeline in the MrSteam Steam Bath Installation and Operation Manual. Visit [www.mrsteam.com](http://www.mrsteam.com) to download this document.

3. Install Check Valve into 90° **T**/adaptor.

**!WARNING** The Check Valve prevents excessive amounts of fragrance from entering the steam line and steam room. Never install the AromaSteam System without the Check Valve. Failure to install the Check Valve may result in excessive fragrance delivery into the steam room and cause dizziness and/or personal injury.

### PRESSURE TUBE ASSEMBLY

For your convenience the pressure tube assembly is provided pre-assembled. If additional tubing is needed please contact MrSteam Technical service at 1-800-767-8326 or 1-800-727-8326.

#### Installation of Pressure Tube to the Pump

1. Insert the pressure tube through the hole of the pump tightening nut and collar and firmly push the tube onto the tube holder.
2. Screw the pump tightening nut onto the pump and tighten the nut by HAND only.

#### Installation of Pressure Tube to the 90° T

1. Insert the pressure tube through the Check Valve tightening nut and collar and firmly push the pressure tube onto the tube holder.
2. Screw the Check Valve tightening nut onto the Check Valve.

**IMPORTANT NOTE:** To prevent connection from leaking, insert tubing holder completely into tubing until it reaches the bottom. Lubricate the ID of the tubing as required with soap to facilitate insertion.

**IMPORTANT NOTE:** To prevent damage do not use tools to tighten the nut.

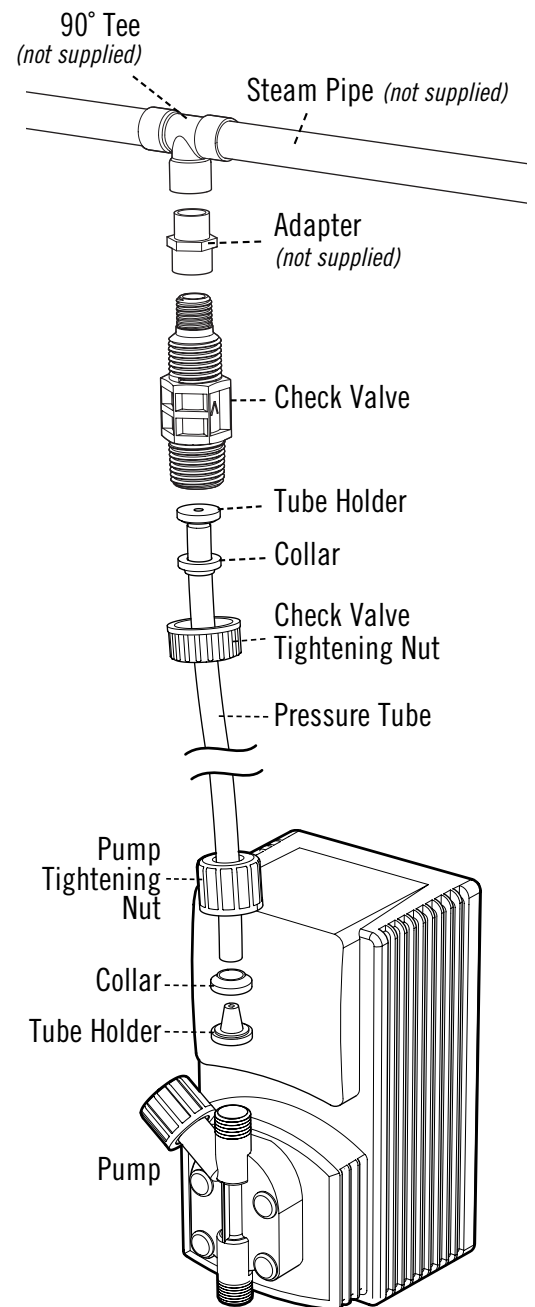



## INSTALLER SECTION

### SUCTION TUBE ASSEMBLY

For your convenience the suction tube assembly is provided preassembled. If additional tubing is needed please contact MrSteam Technical service at 1-800-767-8326 or 1-800-727-8326.

#### Installation of Suction Tube to the Pump

1. Insert the suction tube through the pump tightening nut and collar and firmly push the tube onto the tube holder.
2. Screw the suction tube tightening nut to the suction side of the pump.

**IMPORTANT NOTE:** HAND-TIGHTEN ONLY.

#### Installation of Suction Tube into the Fragrance Container

1. Locate the "container cap" with the hole included with the bottle of fragrance.
2. Insert the suction tube through the hole in the container cap.
3. Remove the foot valve cap and insert the suction tube through the cap. Push the suction tube onto the foot valve. Tighten the cap onto the foot valve.
4. Unscrew the cap from the fragrance container and discard.
5. Screw the cap onto the fragrance container.
6. Make sure the Foot Valve rests on the bottom of the fragrance container.

**IMPORTANT NOTE:** To prevent connection from leaking, insert tubing holder completely into tubing until it reaches the bottom. Lubricate the ID of the tubing as required with soap to facilitate insertion.

**IMPORTANT NOTE:** To prevent damage do not use tools to tighten the nut.

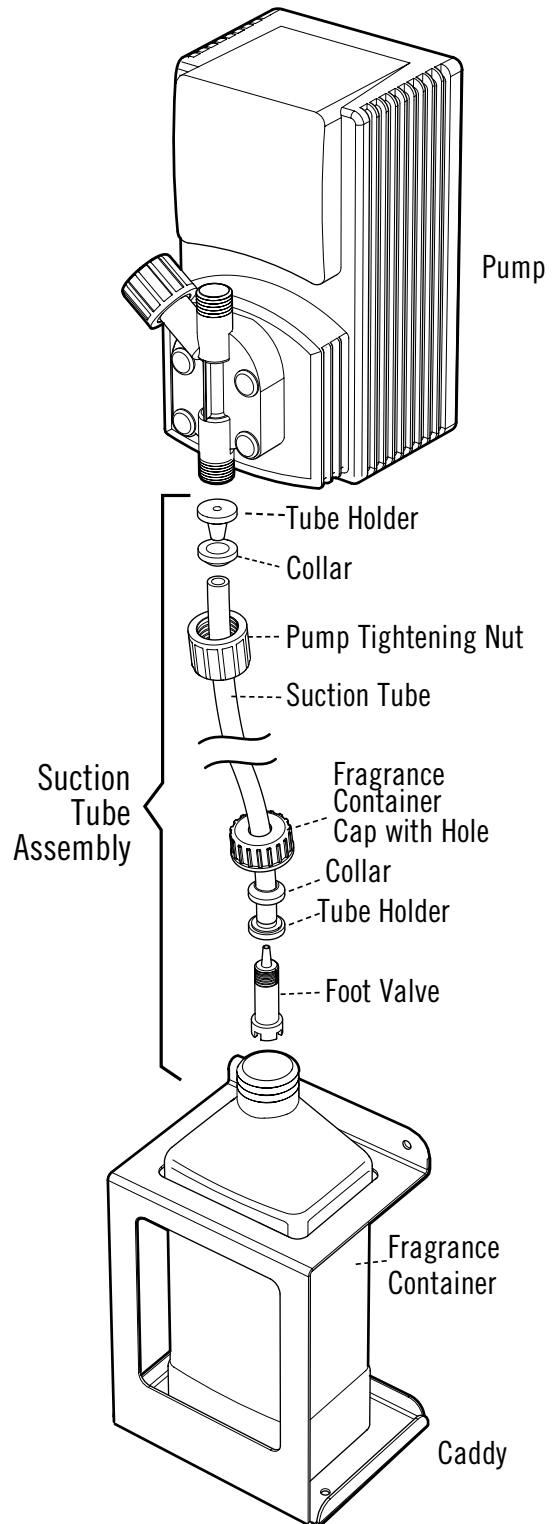

## INSTALLER SECTION

### Priming the Pump

1. Insure MrSteam fragrance container is full.
2. Insert a short piece of soft injector tube onto the tip of the injector (see Fig. 1).
3. Insert the open end of the injector tube onto the pressure valve (see Fig. 1).
4. Open the priming valve by turning the knob counter clockwise one full revolution.
5. Draw liquid from the injector slowly and evenly. Continue until the injector is full of liquid.
6. If you have drawn up the injector completely and no liquid is in the injector, remove the injector tube from the pressure valve.
7. Drain injector. Repeat steps until the injector is filled.
8. Save the fragrance injector as it may be needed when new fragrances are used.
9. Close the priming valve completely by turning the knob clockwise.

**CAUTION** Failing to close the valve will result in fragrance leaking from the priming port.

**IMPORTANT NOTE:** If an extended pressure tube is special ordered then contact MrSteam Technical Service (see page 20) for instructions for filling the pressure tube with fragrance.

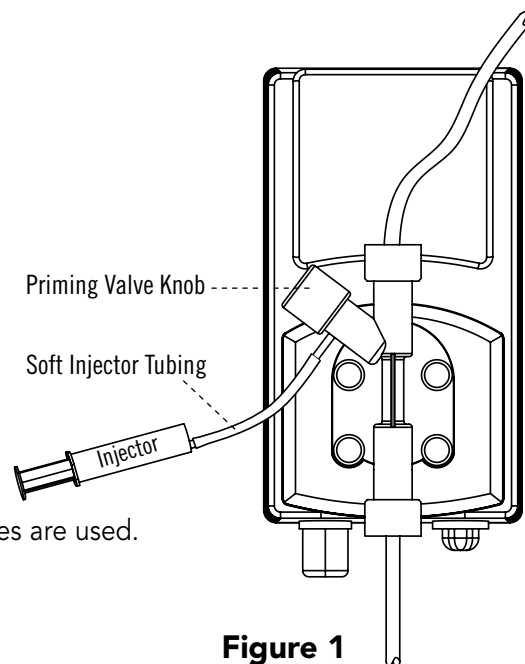

**Figure 1**

# INSTALLER SECTION

## Electrical Connection of AromaSteam System

**CAUTION** This AromaSteam system is factory wired. If the power cord of the AromaSteam pump is damaged it must be replaced by the MrSteam service department or similarly qualified personnel in order to avoid an electric shock hazard. All electrical connections to be made by a licensed, qualified electrician. Disconnect all power to the steam generator before making power connections.

**IMPORTANT NOTE:** AromaSteam system is for use with AirTempo® iSteam® and iTempoPlus® controls only.

1. Disconnect all power to the MrSteam steam generator. Failure to disconnect power may result in an electrocution hazard. Remove the top cover.
2. Run the request cable from the AromaSteam pump through one of the knock outs in the side of the steam bath generator. Use a strain relief bushing or grommet to prevent chafing.
3. Locate the two quick connect tabs labeled "AROMA" on the printed circuit board in the location shown.
4. Connect the request cable to the terminals. The terminals are not polarized.

## AromaSteam Wiring Schematic

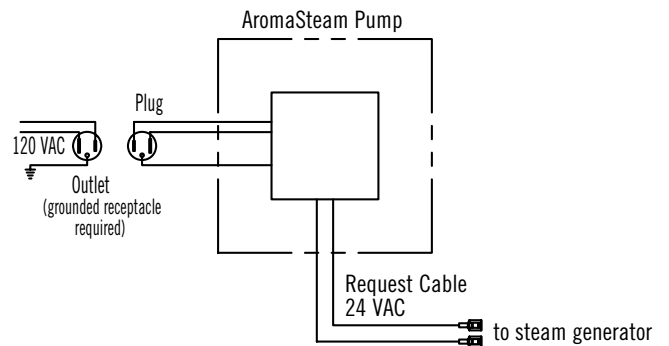

## AromaSteam Connections

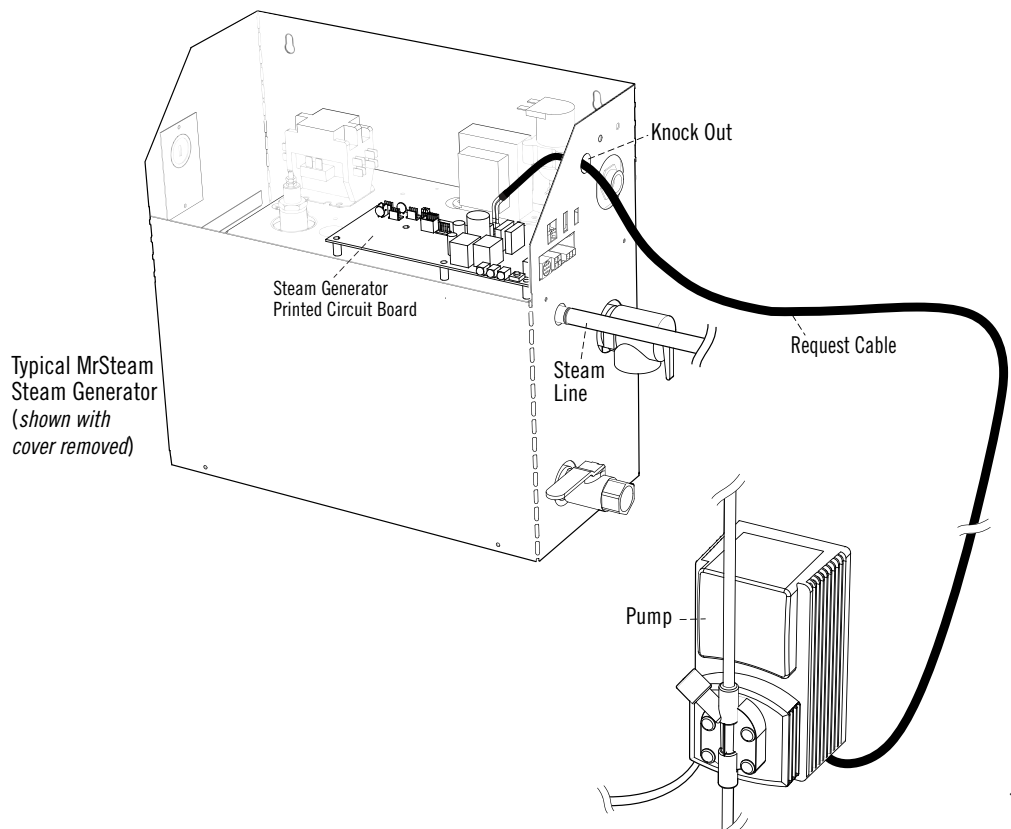
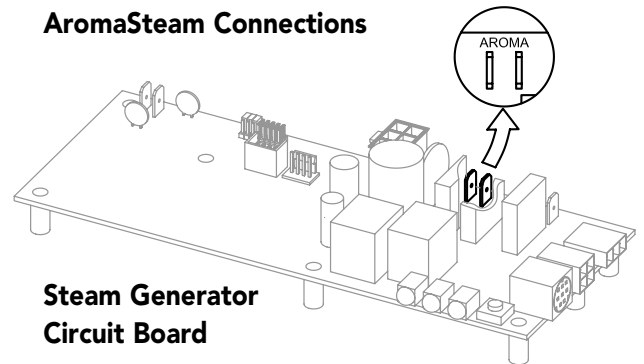

## INSTALLER SECTION

### OPERATION

#### Powering Up the Pump

**IMPORTANT NOTE:** This step only needs to be performed during installation.

1. The pump needs to be turned on before it can be used
2. Press and hold the power button for 3 seconds.  
The LED will turn on solid red.

**PUMP LED LIGHT: KEY:**

- Flashing Green LED Pump is OFF. Press and hold the power button for 3 seconds to turn the pump on.
- Solid Red Pump is ON, but has not been activated. To activate the pump, turn your steam generator ON from the in-shower control and press the aroma button.
- Solid Green LED Pump is on and has been activated from the in-shower control.  
The LED will turn off each time the pump injects fragrance into the steam line.

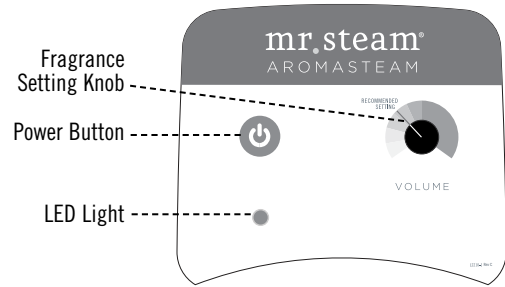

#### Adjusting the Amount of Fragrance Delivery

The AromaSteam system has been factory set to deliver a suitable amount of aromatic fragrance into a typical sized steam room. Do not exceed the maximum setting. Please contact the MrSteam Technical Service Department before changing this setting.

Contact the MrSteam Technical Service Dept. at (800) 76-STEAM (East coast) or (800) 72-STEAM (West Coast) for assistance or additional information.

**!WARNING** Increasing the settings may introduce excessive concentration of fragrance into the steam room, resulting in a health hazard.



#### Activating the Pump from a Control

##### Air Tempo® Control

1. Press the ON/OFF button to turn the steam generator ON.
2. Press the AROMA button, AROMA will be displayed on the screen when AromaSteam is on.
3. Aroma fragrance will automatically be pumped into the steam line at preset intervals.

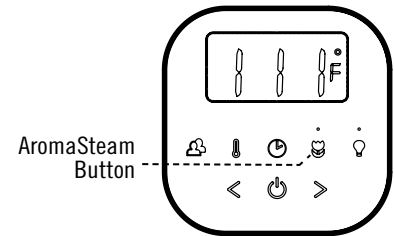

##### iSteam® Control

1. Press the START button to turn the steam generator on.
2. In the dashboard press the AROMA button, the button will be highlighted when AromaSteam Pump is on.
3. Aroma fragrance will automatically be pumped into the steam line at preset intervals.

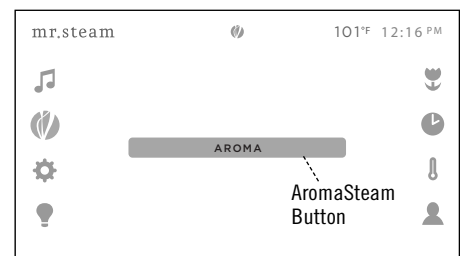

##### iTempoPlus® Control

1. Press the ON/OFF button to turn the steam generator ON.
2. Press the AROMA button, AROMA will be displayed on the screen when AromaSteam is on.
3. Aroma fragrance will automatically be pumped into the steam line at preset intervals.

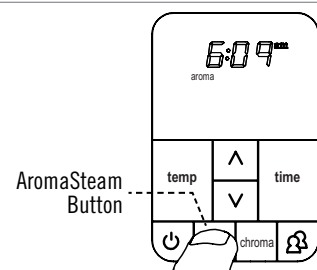

## INSTALLER SECTION

### TROUBLESHOOTING

**⚠️WARNING** TO AVOID ELECTRIC SHOCK, DISCONNECT POWER TO PUMP BEFORE SERVICING

#### Pump does not prime

1. Check if voltage is available.
2. Check liquid level in fragrance container. Replenish liquid, if necessary.
3. Check for air bubbles in the suction tube or the pump head. To eliminate air bubbles see: Priming Pump.
4. Check valves for contamination. Clean valves if necessary.
5. Check foot valve in container for contamination. Rinse foot valve under clean water.

#### Pump does not inject fragrance into steam room

1. Check if voltage is available.
2. Check liquid level in fragrance container. Replenish fragrance if necessary.
3. Check for air bubbles in the suction tube or the pump head. To eliminate air bubbles see: Priming Pump.
4. Check valves for contamination. Clean valves if necessary.
5. Check foot valve in container for contamination. Rinse foot valve under clean water.
6. Check the pressure tube for kinking or jamming. Straighten or replace.
7. Check if fragrance is freely flowing through the Check Valve when the metering pump is energized. Apply compressed air through the Check Valve. Attach the compressed air at the point of connection of the pressure tube.
8. Ensure the pump has been powered up. See page 12.

#### Pump fragrance delivery too much or too little

**⚠️WARNING** The AromaSteam system has been factory set to deliver a suitable amount of aromatic fragrance into a typical sized steam room. Please contact the MrSteam Technical Service Department before changing this setting. See page 12 for instructions on adjusting the amount of fragrance delivery.

Contact the MrSteam Technical Service Dept. at (800) 76-STEAM (East coast) or (800) 72-STEAM (West Coast) for assistance or additional information.

**⚠️WARNING** ELECTRICAL SHOCK HAZARD. MrSteam AromaSteam pumps are connected to 120V line voltage and contain live electrical components. All installation and service to be performed by qualified and licensed electricians and plumbers only. Installation or service by unqualified persons or failure to use MrSteam parts may result in property damage or in a hazardous condition.

# INSTALLER SECTION

## REPLACEMENT PARTS

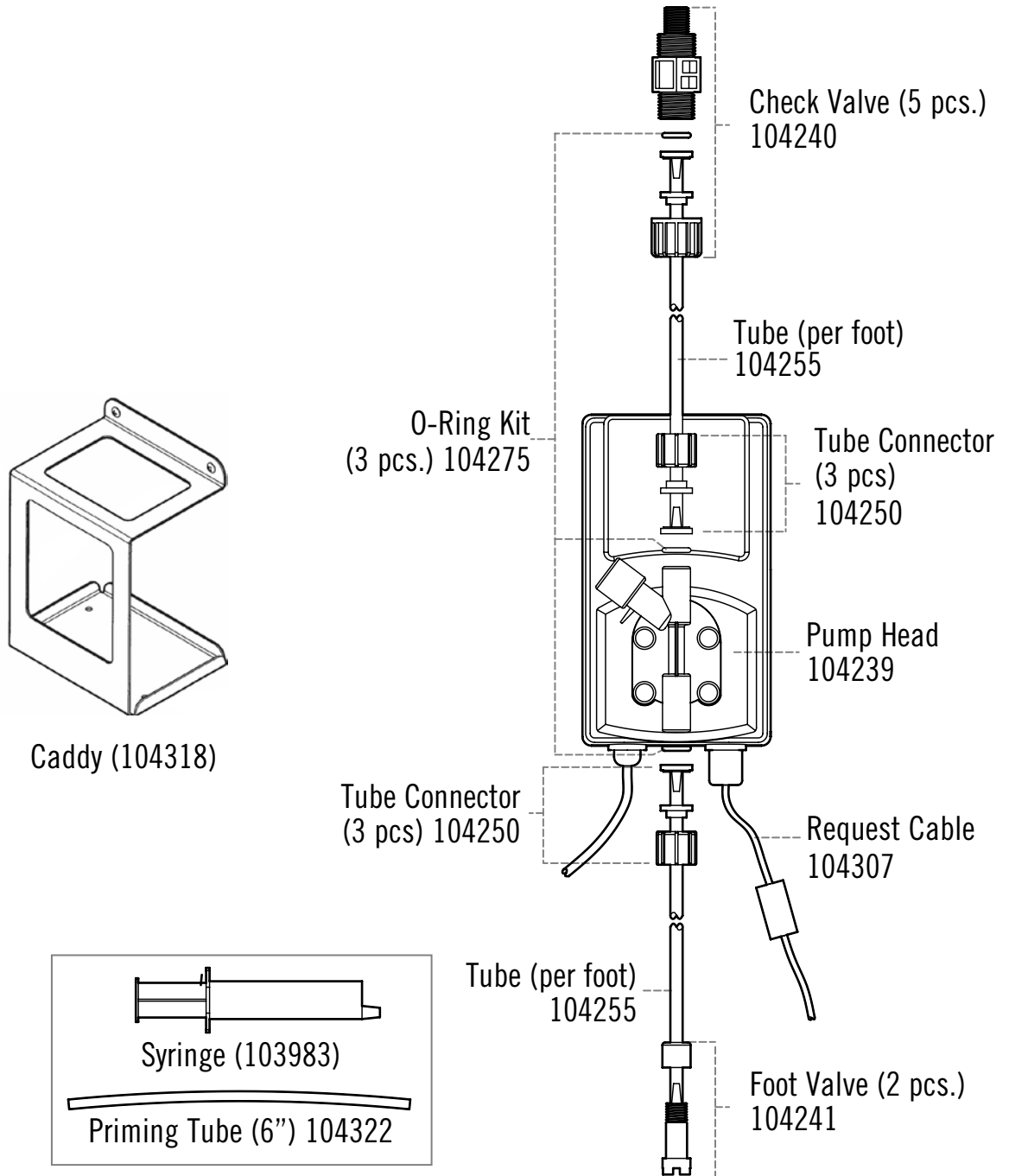

# INSTALLER SECTION

## Installing the Caddy:

### Box Contents:

- Stainless steel caddy
- Mounting screws (2)
- Instructions

### Tools required:

- Cordless drill with a Phillips bit
  - Level
- \*Use only non-sparking tools. Take precautionary measures against static discharge

### Locating the Caddy:

1. Place in a location that allows visual monitoring of the fragrances level.
2. Place in a location that allows for easy replacement of the fragrance container.
3. The caddy should not be installed in areas accessible to children. A locked room is strongly recommended (ie: utility room).
4. The caddy must be installed below the pump. The maximum distance from the pump to the bottom of the caddy is 6 feet. (Diagram 1)
5. The caddy is designed and intended for indoor use only. Do not install outdoors.
6. Do not install in an unheated location where water could freeze.
7. Locate in a area where the ambient temperature does not exceed 88° F.

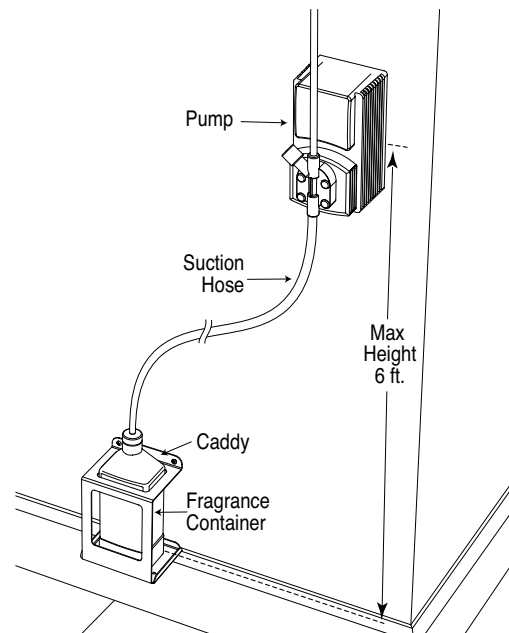
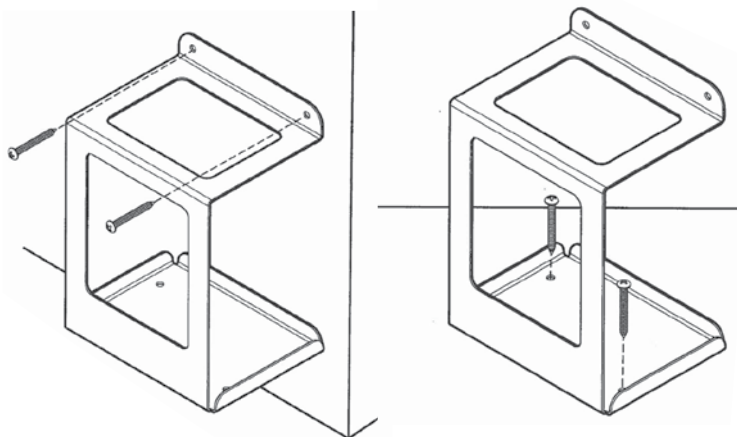

**Diagram 1**

*Drawing details removed for clarity*

### Mounting the Caddy on a Wall:

1. Use a level to make sure the caddy is level.
2. Use the two mounting screws provided to secure the caddy using the two holes at the top of the caddy (Diagram 2).
3. Use anchors or other hardware as required for secure mounting. Test the caddy for secure mounting.
4. Insert the fragrance container with the label facing outward so it is visible through the caddy window (Diagram 4). The label contains important information.
5. Connect the fragrance container to the pump according to instructions in the AromaSteam Fragrance Dispensing Pump Installation, Operation Manual (PUR 100402) (Diagram 5).
6. Always keep the container in the caddy while it is connected to the dispensing pump.



**Diagram 2**

**Diagram 3**

### **! WARNING**

Using a fragrance container that is not secured in the caddy, or using a caddy that is not mounted may result in spillage, excessively strong vapors or a fire hazard.

## INSTALLER SECTION

### Mounting the Caddy on a Floor:

1. Use the two mounting screws provided to secure the caddy using the two holes at the bottom of the caddy (Diagram 3).
2. Use anchors or other hardware as required for secure mounting. Test the caddy for secure mounting.
3. Insert the fragrance container with the label facing outward in a manner it is visible through the caddy window (Diagram 4). The label contains important information.
4. Connect the fragrance container according to instructions in the AromaSteam Fragrance Dispensing Pump Installation, Operation Manual (PUR 100402).
5. Always keep the container in the caddy while it is connected to the dispensing pump.

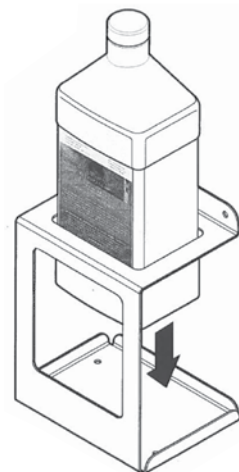

Diagram 4

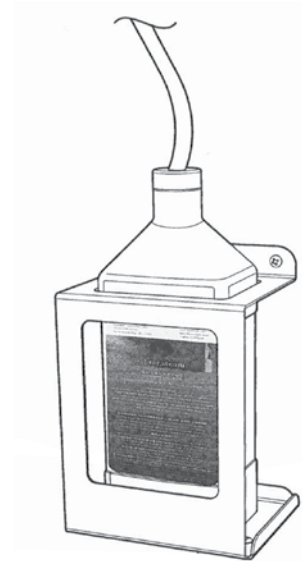

Diagram 5

**! WARNING**

Using a fragrance container that is not secured in the caddy, or using a caddy that is not mounted may result in spillage, excessively strong vapors or a fire hazard.



# H O M E O W N E R   S E C T I O N



MrSteam Aroma Fragrances  
(MS OIL 1-5)

**The AromaSteam’s state-of-the-art pump introduces fragrance into the steam pipe and into your steam shower.**

**MrSteam Aroma is Available in These Five Fragrances:**

FRAGRANCE	PART NO.	CONTAINER VOLUME.
<b>Eucalyptus</b>	(MS OIL 1)	1 liter /33 fl.oz.
A deeply refreshing aroma with cleansing effects, eucalyptus may help open air passageways.		
<b>Lavender</b>	(MS OIL 2)	1 liter /33 fl.oz.
A sweet, lightly floral scent, lavender may help soothe anxiety with its calming & restorative properties.		
<b>Evergreen</b>	(MS OIL 3)	1 liter /33 fl.oz.
A refreshing blend of spruce, fir and pine reminiscent of a forest on a crisp morning.		
<b>Energizing Mint</b>	(MS OIL 4)	1 liter /33 fl.oz.
A blend of mint, citrus and herbs that may stimulate and energize.		
<b>Breathe</b>	(MS OIL 5)	1 liter /33 fl.oz.
A tropical combination that may help clear chest, nose and sinuses.		

The Safety Data Sheet provides comprehensive information about MrSteam Aroma fragrances. Contact 1-800-767-8326 or go online at [www.mrsteam.com](http://www.mrsteam.com) for a copy of the Safety Data Sheet.

**READ ME FIRST!**

**!WARNING** As you follow these instructions, you will notice warning and caution symbols. This blocked information is important for the safe and efficient installation and operation of this generator. These are types of potential hazards that may occur during installation and operation:

**!WARNING** Indicates a potentially hazardous situation, which, if not avoided, could result in death or serious injury.

**!CAUTION** Indicates a potentially hazardous situation, which, if not avoided may result in minor or moderate injury or product damage.

**IMPORTANT NOTE:** This highlights information that is especially relevant to a problem-free installation.

All information in these instructions is based on the latest product information available at the time of publication. Sussman-Automatic Corporation reserves the right to make changes at any time without notice.

## HOMEOWNER SECTION

### IMPORTANT SAFETY INSTRUCTIONS READ AND FOLLOW ALL INSTRUCTIONS

#### WARNING

##### FLAMMABLE LIQUID AND VAPOR

- Keep the pump and fragrance away from heat, sparks, electrical outlets, open flames such as candles and hot surfaces.
- No smoking.
- Keep Out of the Reach of Children.
- Contains denatured ethyl alcohol.
- In case of fire: Use CO2, dry chemical, alcohol foam, and water spray for extinction.
- Always store the MrSteam Aroma fragrances in a secure location. Keep container tightly closed and store in a cool, dry and well-ventilated place.

#### WARNING

- Avoid fragrance contact with eyes. May cause mild eye irritation. Ingestion may cause irritation, nausea, vomiting.
- Fragrance vapors may cause drowsiness, allergic reactions, difficulty breathing or skin irritation. If condition persists get medical attention.
- The Fragrance Safety Data Sheet provides comprehensive information about MrSteam Aroma fragrances. Contact 1-800-767-8326 or go online at [www.mrsteam.com](http://www.mrsteam.com) for a copy of the Safety Data Sheet.
- MrSteam fragrances (MS OIL 1- 5) are only for use with the MrSteam AromaSteam dispensing pump (part number MS AROMA and MS AROMAC). Never use MrSteam fragrances in any other pump, spray or dispensing device. The use of MrSteam fragrances in any other device may cause personal injury.
- The use of any fragrances other than MrSteam fragrances with a MrSteam AromaSteam dispensing pump may introduce excessive concentration of fragrances into the steam room, resulting in personal injury.
- Keep out of the reach of children.
- The AromaSteam pump has been factory set to deliver a suitable amount of fragrance into a typical sized residential or Day Spa steam room. Start with the pump volume at a very low setting. Gradually increase the volume setting until a comfortable fragrance level is reached. Do not exceed the "Recommended Setting" indicated on the pump volume.
- Do Not alter or modify any MrSteam product. Doing so may result in a personal injury.

#### FIRST AID

**IN CASE OF EYE CONTACT:** Rinse the eyes immediately with plenty of water, also under the eyelids, for at least 15 minutes. If eye irritation persists: Get medical attention.

**IN CASE OF SKIN CONTACT:** Remove/Take off immediately all contaminated clothing. Rinse skin with soap and water or shower. If skin irritation persists, get medical attention.

**IF SWALLOWED:** Do not induce vomiting. Rinse mouth thoroughly with water. If conscious, give large amounts of water. If symptoms persist, call a physician.

#### IMPORTANT NOTES:

- Not for use in acrylic or fiberglass rooms. Check with the room manufacturer to determine compatibility of these fragrances with room construction materials.
- Do Not alter or modify any MrSteam product. Doing so will void the warranty.
- MrSteam Aroma fragrances must be disposed of as hazardous waste.

# HOMEOWNER SECTION

### Locating the Caddy/Fragrance:

1. Place in a location that allows visual monitoring of the fragrances level.
2. Place in a location that allows for easy replacement of the fragrance container.
3. The caddy should not be installed in areas accessible to children. A locked room is strongly recommended (ie: utility room).
4. The caddy is designed and intended for indoor use only.  
Do not install outdoors.
5. Do not install in an unheated location where water could freeze.
6. Locate in a area where the ambient temperature does not exceed 88° F.

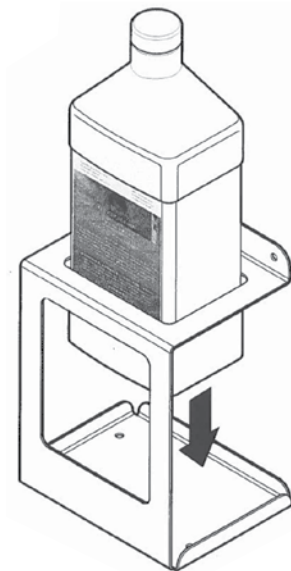

Diagram 1

	<b>WARNING</b>
Using a fragrance container that is not secured in the caddy, or using a caddy that is not mounted may result in spillage, excessively strong vapors or a fire hazard.	

7. Insert the fragrance container with the label facing outward so it is visible through the caddy window (Diagram 1). The label contains important information.
8. Always keep the container in the caddy while it is connected to the dispensing pump.

## OPERATION

### Powering Up the Pump

**IMPORTANT NOTE:** This step only needs to be performed during installation.

1. The pump needs to be turned on before it can be used
2. Press and hold the power button for 3 seconds.  
The LED will turn on solid red.

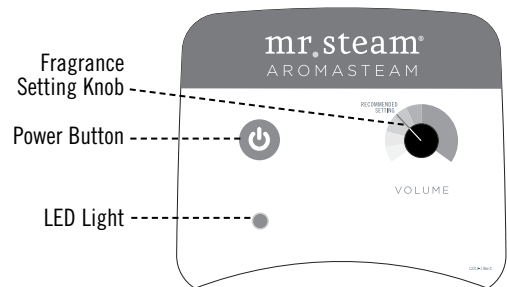

<b>PUMP LED LIGHT:</b>	<b>KEY:</b>
Flashing Green LED	Pump is OFF. Press and hold the power button for 3 seconds to turn the pump on.
Solid Red	Pump is ON, but has not been activated. To activate the pump, turn your steam generator ON from the in-shower control and press the aroma button.
Solid Green LED	Pump is on and has been activated from the in-shower control. The LED will turn off each time the pump injects fragrance into the steam line.

# HOMEOWNER SECTION

## OPERATION (cont.)

### Adjusting the Amount of Fragrance Delivery

The AromaSteam system has been factory set to deliver a suitable amount of fragrance into a typical sized steam room. Do not exceed the maximum setting. Please contact the MrSteam Technical Service Department before changing this setting.

Contact the MrSteam Technical Service Dept. at (800) 76-STEAM (East coast) or (800) 72-STEAM (West Coast) for assistance or additional information.

**!WARNING** Increasing the settings may introduce excessive concentration of fragrance into the steam room, resulting in a health hazard.



### Activating the Pump from a Control

#### Air Tempo® Control

1. Press the ON/OFF button to turn the steam generator ON.
2. Press the AROMA button, AROMA will be displayed on the screen when AromaSteam is on.
3. Aroma fragrance will automatically be pumped into the steam line at preset intervals.

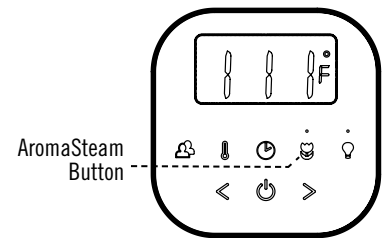

#### iSteam® Control

1. Press the START button to turn the steam generator on.
2. In the dashboard press the AROMA button, the button will be highlighted when AromaSteam Pump is on.
3. Aroma fragrance will automatically be pumped into the steam line at preset intervals.

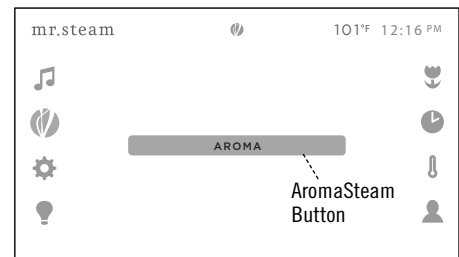

#### iTempoPlus® Control

1. Press the ON/OFF button to turn the steam generator ON.
2. Press the AROMA button, AROMA will be displayed on the screen when AromaSteam is on.
3. Aroma fragrance will automatically be pumped into the steam line at preset intervals.

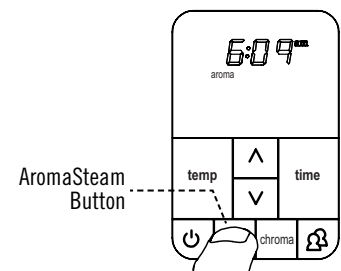

**WARRANTY:** To view or download the MrSteam AromaSteam System Warranty and register your product go to: [blog.mrsteam.com/wr](http://blog.mrsteam.com/wr)

Products, information and specifications are subject to change without notice.

For more information please call Sales & Support at

**1.800.76.STEAM** (East Coast) **1.800.72.STEAM** (West Coast) [www.mrsteam.com](http://www.mrsteam.com)